

# Container 2340 Liter, Typ TB 25/L

# ARICON

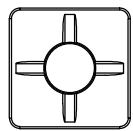
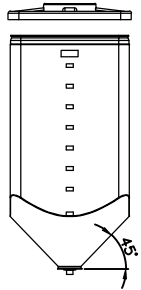
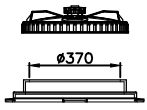

Innenbehälter

Entleerung

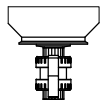

Vertikal

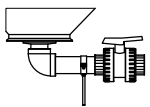

Horizontal

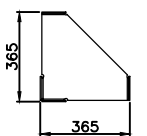
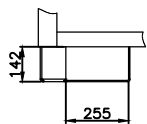

Staplerschuhe AR

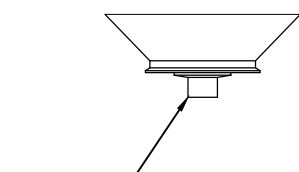
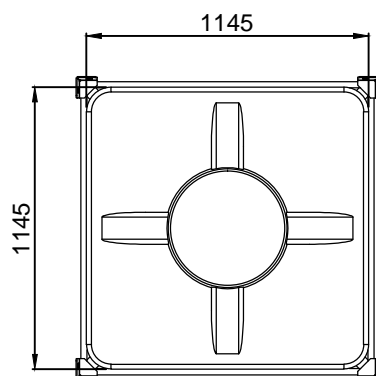
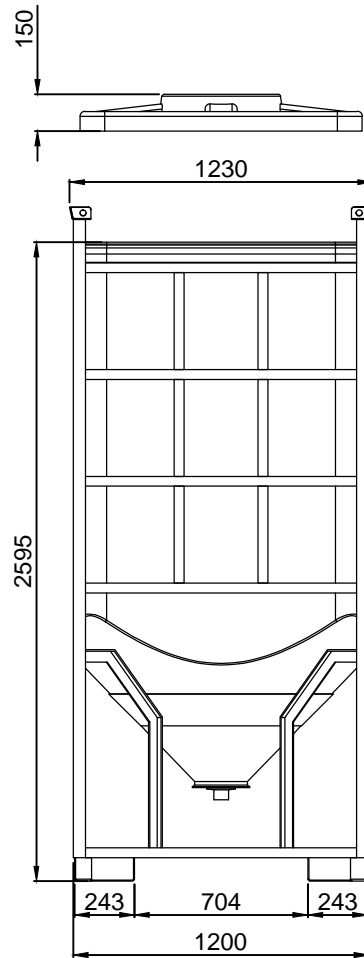
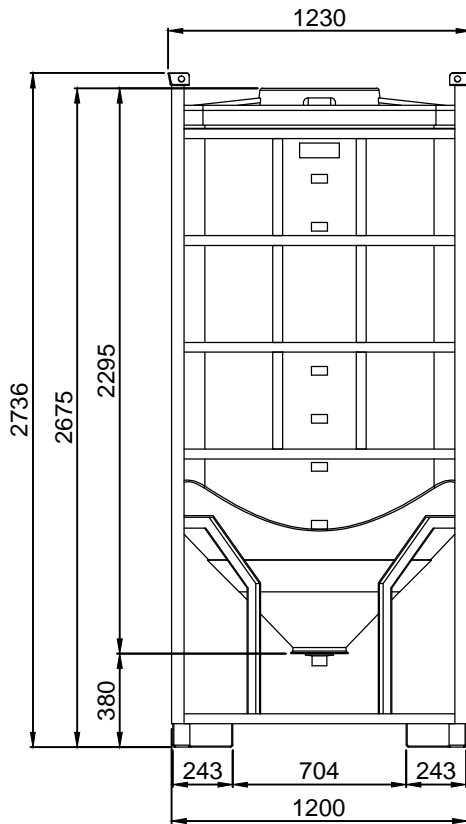

Entleerung: 1"-1 1/4"-1 1/2"-2"-2 1/2"-3"-4"

