

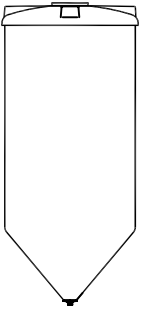

Container 16.250 Liter, Typ TCC 160-2/P

Innenbehälter

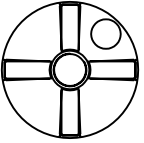

LT. ~900

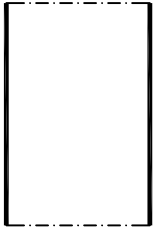

LT. ~13650



LT. ~1700

Entleerung

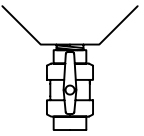

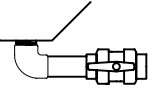

Vertikal

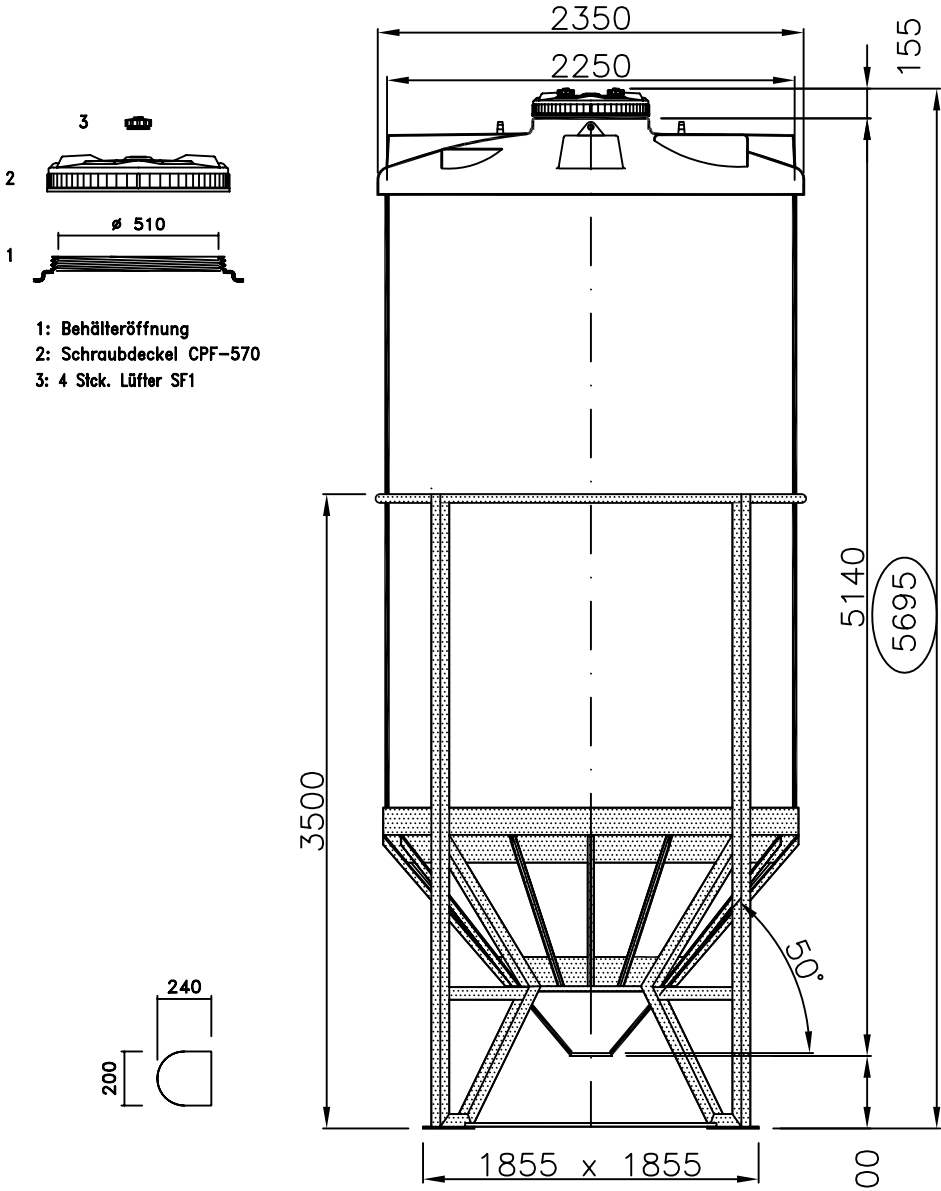

Horizontal



- 3 
- 2 
- 1 
- 1: Behälteröffnung
2: Schraubdeckel CPF-570
3: 4 Stck. Lüfter SF1

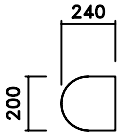

Montageflächen

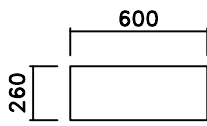

Ø 2380

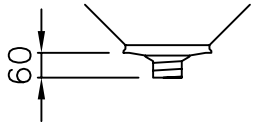
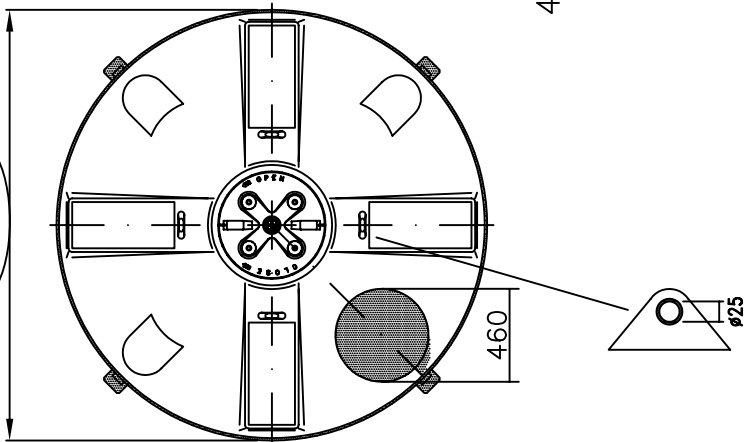

1" - 1¼" - 1½" - 2" - 2½" - 3" - 4"