

Container 4.100 Liter, Typ TCA 41/L

Deckel

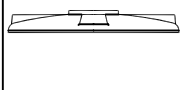

Innenbehälter

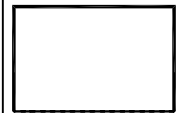

LT. ~3620



LT. ~480

Entleerung

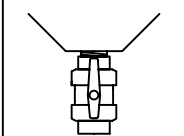

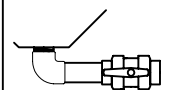

Vertikal

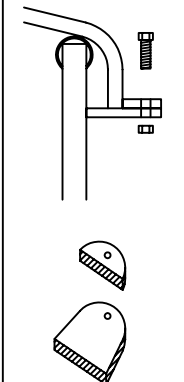

Horizontal

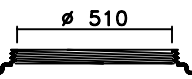

Optional

- 3 
 - 2 
 - 1 
- 1: Behälteröffnung
 2: Schraubdeckel CPF-570
 3: 2 Stck. Lüfter SF1

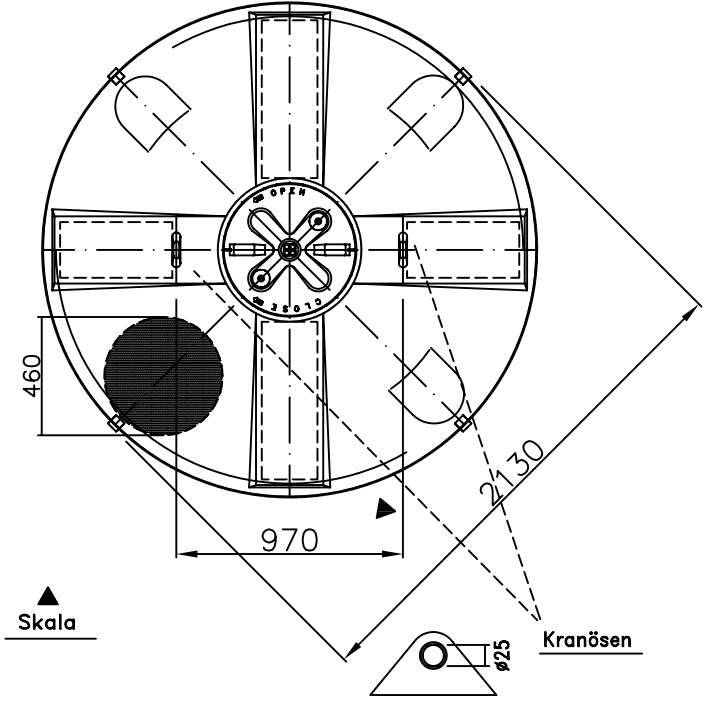
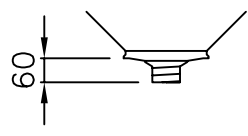
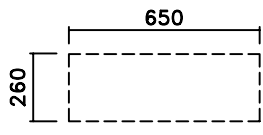
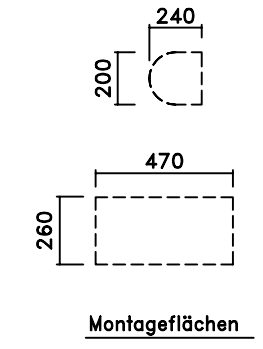
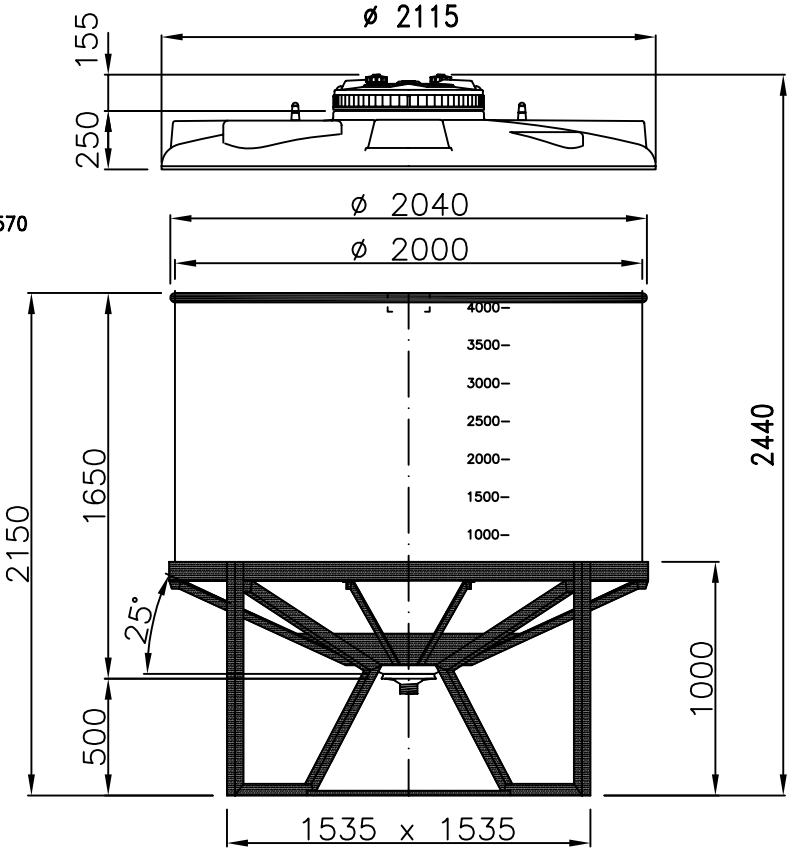

1" - 1 1/4" - 1 1/2" - 2" - 2 1/2" - 3" - 4"