



## Container 370 Liter, Typ TC 4/L

**Lüfter**

ø 285

**CPM-300**

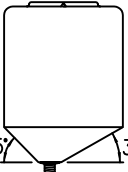

45° 30°

**Innenbehälter**

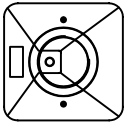

**Entleerung**



**Vertikal**

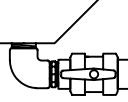

**Horizontal**

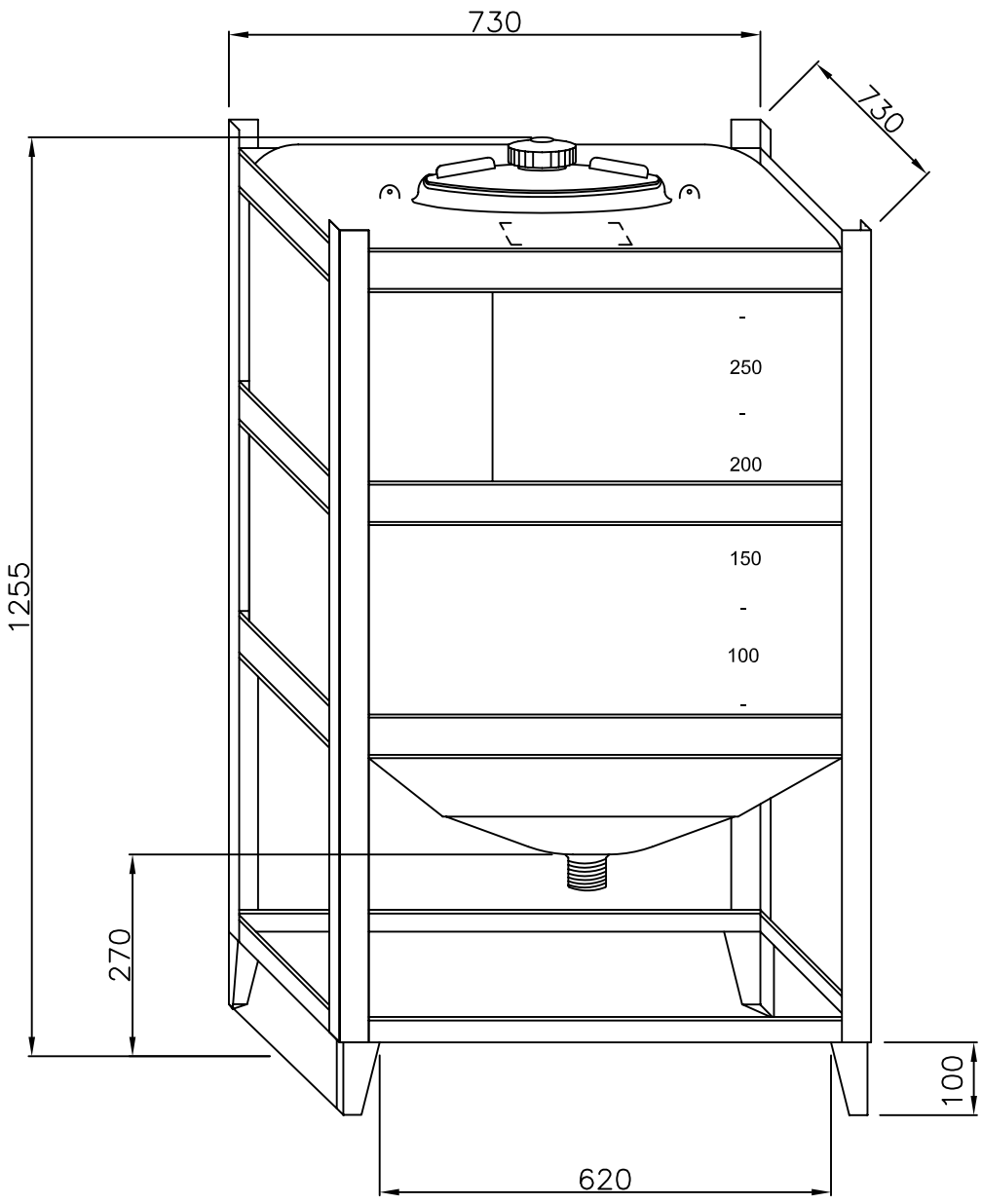

Entleerung : ø 1" - 1¼" - 1½" - 2" Containerhöhe 1255 mm

Entleerung : ø 2½" - 3" - 4" Containerhöhe 1485mm