



Container 200 Liter, Typ TC 2/L

Löffel

Ø 155

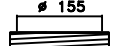

CPF-200

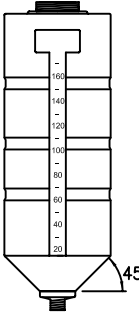

Innenbehälter

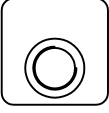

Entleerung

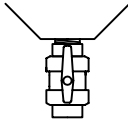

Vertikal

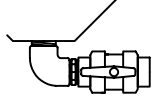

Horizontal

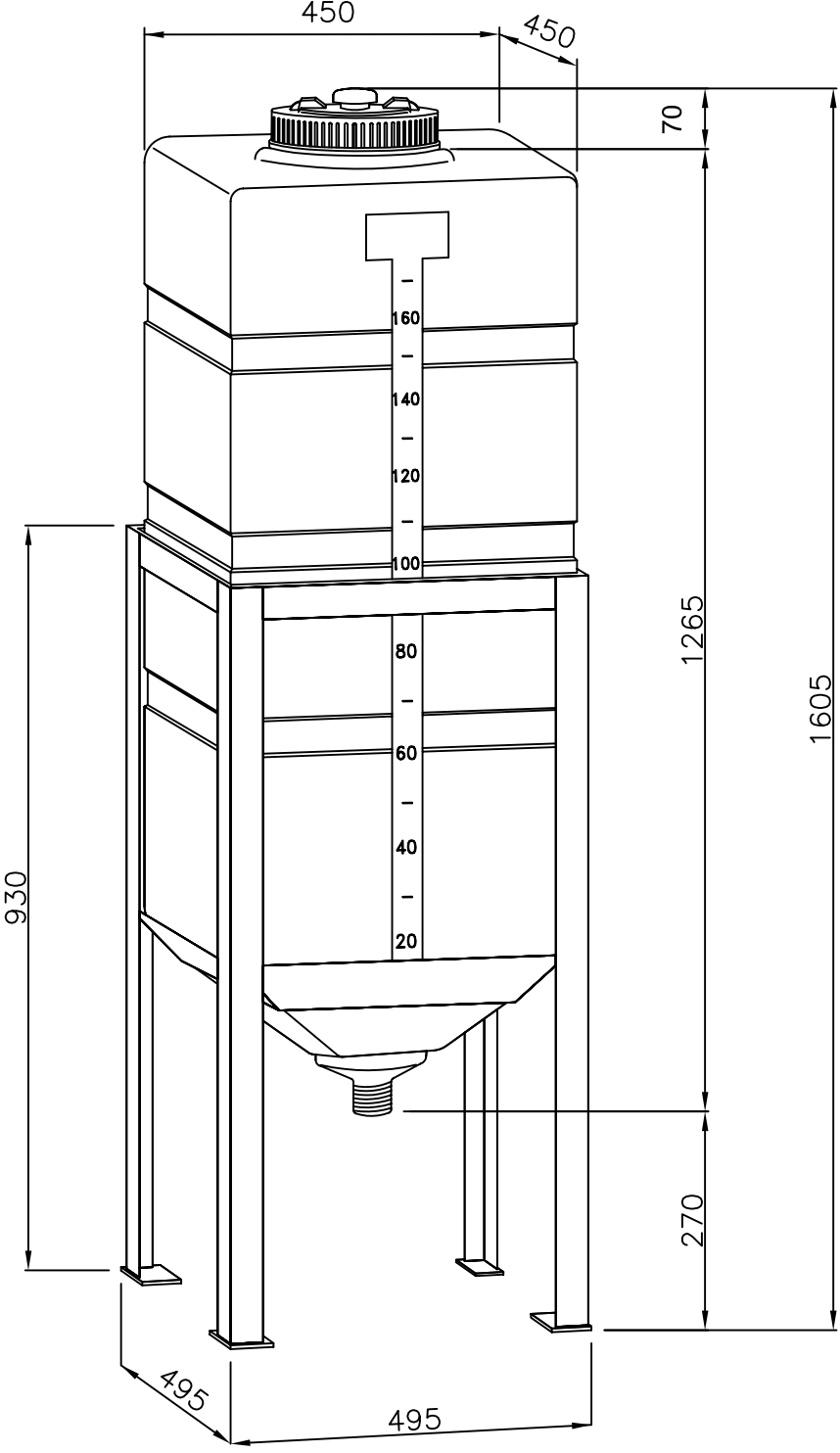

 = 1" - 1¼" - 1½" - 2" - 2½" - 3" - 4"